

## TBLDC32-2 V-Y- $\Delta$ DC-LISN

The TBLDC32-2 is a Line Impedance Stabilization Network for the measurement of conducted emissions on DC lines within the range of 9 kHz to 30MHz, according to the CISPR 16-1-2 and CISPR 11 standard. The device is designed for testing disturbance voltages at DC power ports of semiconductor power converters and similar equipment with DC supply voltages up to maximum 1000V and 32A. Conducted emissions can be measured on the forward and return supply line. Furthermore, the rotary switch at the front panel enables measurement of common mode and differential mode emissions. The TBLDC32-2 is equipped with air core inductors. The enclosure has a robust stainless steel base with flanges for ground connection.



TBLDC32-2, DC LISN V – Y -  $\Delta$

### Features

- Frequency range: 9 kHz to 30 MHz
- Max. continuous current: 25A
- Max. current for 15 minutes: 32A
- Max. DC – voltage: 1000 V
- Mode A, mode B impedance:  $150 \pm 30 \Omega$
- Common mode impedance:  $150 \pm 30 \Omega$
- Differential mode impedance:  $150 \pm 30 \Omega$
- Phase at EUT-port:  $0 \pm 40^\circ$
- EUT-port to AE-port isolation, CM:  $> 20 \text{ dB}$
- EUT-port to AE-port isolation, DM:  $> 40 \text{ dB}$
- Longitudinal conversion loss:  $> 26 \text{ dB}$
- Voltage division factor:  $20 \pm 3 \text{ dB}$
- DC-resistance:  $80 \text{ m}\Omega$  per path typ.
- Air core inductors
- Rotary selection switch for path A, B, CM, DM

- AE-port, EUT-port terminals: 4mm, safety
- Measurement connector:  $50 \Omega$  BNC
- Dimensions, W x H x L: 282 x 150 x 480 mm
- Weight: ca. 9 kg
- Operating Temperature Range:  
 $+5^\circ\text{C} \dots +40^\circ\text{C}$ ; 5% to 80% RH, no condensation

### Application

- EMC conducted emission measurements on DC supply lines

# TBLDC32-2 V-Y- $\Delta$ DC-LISN

## Contents

<b>1</b>	<b>INTRODUCTION</b>	<b>4</b>
1.1	RF OUTPUT	4
1.2	INFORMATIVE SCHEMATIC	4
<b>2</b>	<b>TBDC32-2 CHARACTERISTICS</b>	<b>5</b>
2.1	CONFORMITY	5
2.2	SAFETY	5
2.3	SPECIFICATIONS	5
2.4	FRONT / REAR PANEL	6
2.5	IMPEDANCE AT EUT TERMINALS, MODE A, MODE B	7
2.6	PHASE AT EUT TERMINALS, MODE A, MODE B	7
2.7	IMPEDANCE AT EUT TERMINALS, COMMON MODE	8
2.8	PHASE AT EUT TERMINALS, COMMON MODE	8
2.9	IMPEDANCE AT EUT TERMINALS, DIFFERENTIAL MODE	9
2.10	PHASE AT EUT TERMINALS, DIFFERENTIAL MODE	9
2.11	VOLTAGE DIVISION FACTOR	10
2.12	ISOLATION	11
2.13	LONGITUDINAL CONVERSION LOSS	11
2.14	THERMAL CHARACTERISTICS	12
2.15	SPECTRUM ANALYZER / EMI RECEIVER RF INPUT PROTECTION	12
<b>3</b>	<b>ORDERING INFORMATION</b>	<b>13</b>
<b>4</b>	<b>HISTORY</b>	<b>13</b>

## TBLDC32-2 V-Y-Δ DC-LISN

### **SAFETY**

Operating a LISN involves dealing with potentially lethal voltages and high ground leakage currents. The LISN shall only be operated by qualified staff.



Read this manual carefully and be sure to understand the operation of a LISN. Make sure that the conducted noise pre – compliance test equipment is set up correctly and that the necessary earth connections are reliably bonded to avoid the risk of lethal electric shocks. The ground strap must be securely connected to the protective earth conductor available on site, before making any other electrical connection. This connection must not be separated, until the supply at the AE port is disconnected from the LISN setup.

Always use the LISN together with an attenuator / high pass / transient limiter attached to the input of the spectrum analyzer / EMI receiver.

Take precautions, such as validating the signal amplitude at the RF output prior to connecting a spectrum analyzer or using attenuators, high pass filters and/or limiters to prevent damage to your test receiver or spectrum analyzer.

Do not carry out any modifications or manipulations of the TBLDC-32.

Avoid touching the housing, when operating the LISN at maximum current over extended time. The housing temperature may rise up to 50°C. Turn off the EUT after measurements to avoid unnecessary dissipation.

# TBLDC32-2 V-Y-Δ DC-LISN

## 1 Introduction

Measuring power converters such as photovoltaic inverters at the AC port is not sufficient, as the ripple currents on the cabling of the DC side may also cause significant disturbances.

The TBLDC32-2 is designed to measure conducted emissions on the DC side of power converters. It measures disturbance voltages between the single DC conductors and Ground, the common mode voltage of the conductor pair against ground and the differential mode voltage between both conductors.

### 1.1 RF output

The TBLDC32-2 has a single BNC output. A rotary switch at the front panel enables selection of the desired disturbance voltage.

The TBLDC32-2 RF path does not provide any built in attenuator / filter / limiter.

**Always connect suitable protection device to the RF input of your spectrum analyzer / measurement receiver.**

Take precautions, such as validating the signal amplitude at the RF output prior to connecting a spectrum analyzer or using attenuators and/or limiters such as the Tekbox TBFL1 to prevent damage to your test receiver or spectrum analyzer.

**WARNING:** Ensure that the spectrum analyzer RF input is disconnected when powering on or powering off the DUT. Use an attenuator/limiter in case of any uncertainty concerning the EUT characteristics. After ensuring that the spectrum analyzer is not over-driven, you may remove or reduce external attenuation.

### 1.2 Informative schematic

The simplified schematic below shows the basic topology of the TBLDC32-2 DC LISN.

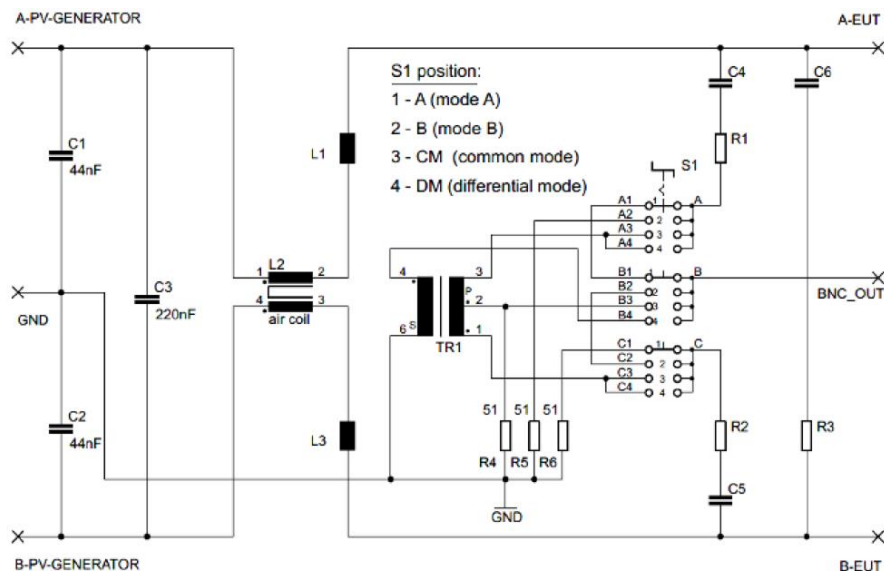

Figure 1 – DC LISN, simplified schematic according CISPR 11

# TBLDC32-2 V-Y-Δ DC-LISN

## 2 TBLDC32-2 characteristics

### 2.1 Conformity

The TBLDC32-2 is compliant with CISPR 16-1-2.

In line with the CISPR 16-1-2 standard compliant design and setup specification, the LISN exhibits non-standard isolation and consequently cannot meet the safety requirements of EN 61010-1.

In order to prevent the danger of lethal electric shock, the operator is responsible for ensuring protective measures in line with IEC 60364-4-41 and IEC 60364-5-54 and to follow all safety related information of this manual.

### 2.2 Safety

In order to ensure safe operations, the user must follow all safety relevant information of this manual. All housing parts including ground flange are connected with the earth receptacle at the EUT port and AE-port. It is not allowed to carry out any modifications or manipulations of the TBLDC32-2. The TBLDC32-2 shall be operated by qualified laboratory staff only.

### 2.3 Specifications

- Frequency range: 9 kHz to 30 MHz
- Max. continuous current: 25A
- Max. current for 15 minutes: 32A
- Max. DC – voltage: 1000 V
- Mode A, mode B impedance:  $150 \pm 30 \Omega$
- Common mode impedance:  $150 \pm 30 \Omega$
- Differential mode impedance:  $150 \pm 30 \Omega$
- Phase at EUT-port:  $0 \pm 40^\circ$
- EUT-port to AE-port isolation, CM: > 20 dB
- EUT-port to AE-port isolation, DM: > 40 dB
- Longitudinal conversion loss: > 26 dB
- Voltage division factor:  $20 \pm 3$  dB
- DC-resistance: 80 mΩ per path typ.
- Air core inductors
- Rotary selection switch for path A, B, CM, DM
- AE-port, EUT-port terminals: 4mm, safety
- Measurement connector: 50 Ω BNC
- Dimensions, W x H x L: 282 x 150 x 480 mm
- Weight: ca. 9 kg
- Operating Temperature Range:
- +5°C ... + 40°C; 5% to 80% RH, no condensation

## TBLDC32-2 V-Y- $\Delta$ DC-LISN

### 2.4 Front / Rear Panel

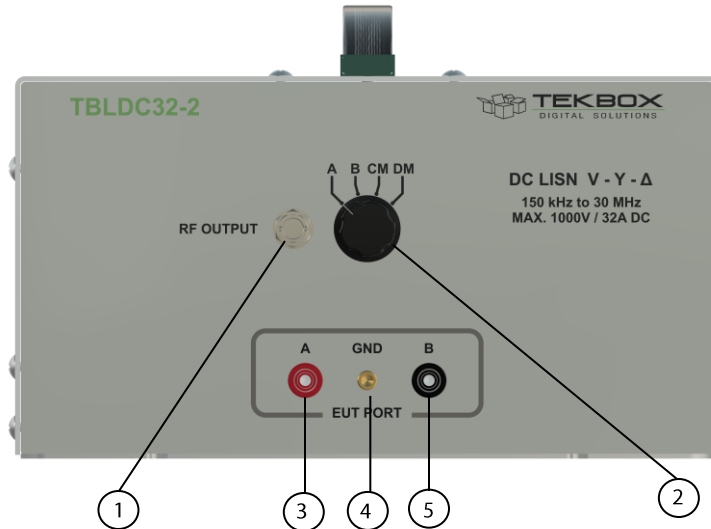

Figure 1 – Front panel layout



Figure 2 – Rear panel layout

- 1) BNC RF - output
- 2) Mode selector switch
- 3) EUT terminal A (path A)
- 4) GND terminal (connected to metal housing)
- 5) EUT terminal B (path B)
- 6) AE terminal B (path B)
- 7) GND terminal (connected to metal housing)
- 8) AE terminal A (path A)

## TBLDC32-2 V-Y-Δ DC-LISN

### 2.5 Impedance at EUT terminals, Mode A, Mode B

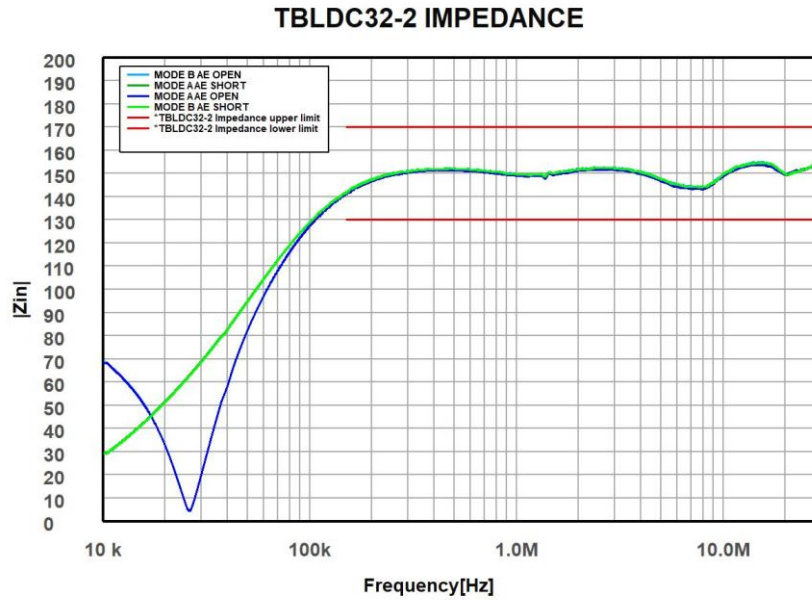

Figure 3 – Impedance [ $\Omega$ ] vs. frequency at EUT terminals, AE terminals open / shorted

### 2.6 Phase at EUT terminals, Mode A, Mode B

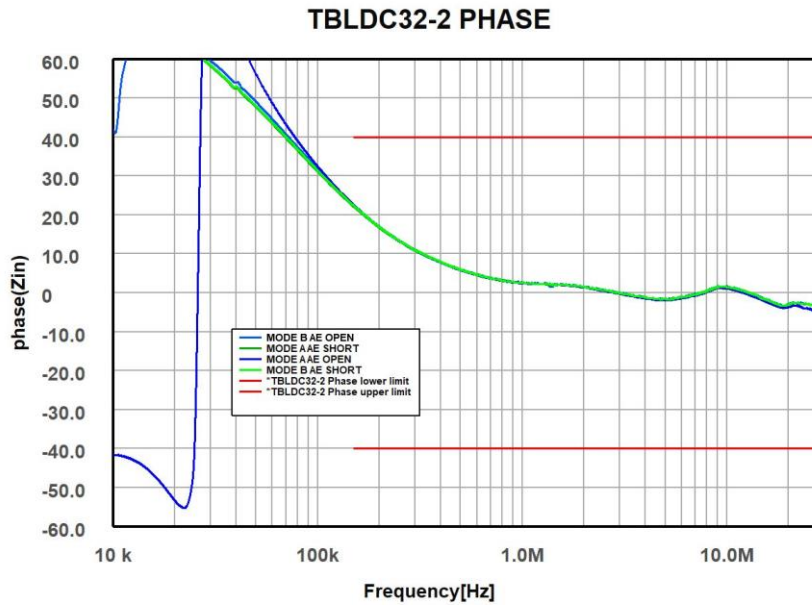

Figure 4 – Phase angle [ $^{\circ}$ ] vs. frequency at EUT terminals, AE terminals open / shorted

## TBLDC32-2 V-Y- $\Delta$ DC-LISN

### 2.7 Impedance at EUT terminals, Common Mode

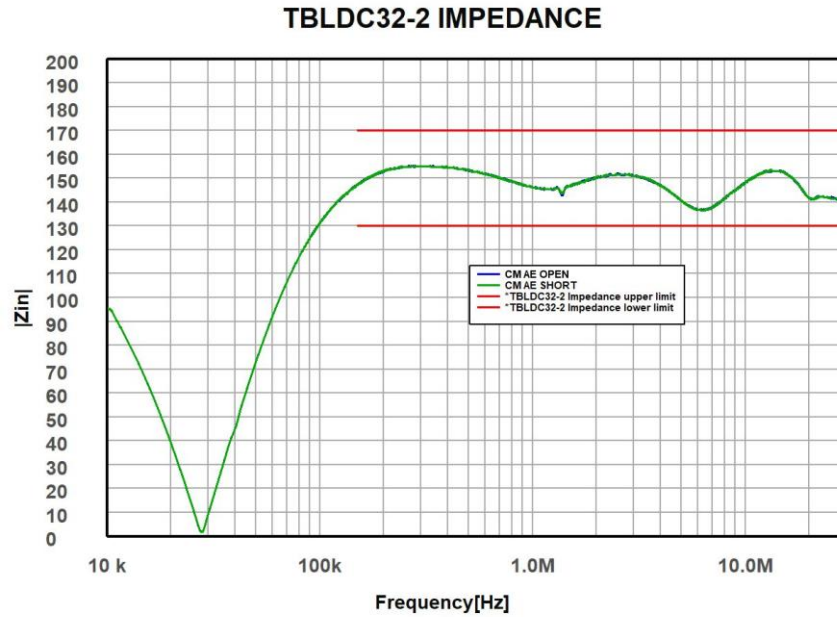

Figure 5 – Impedance [ $\Omega$ ] vs. frequency at EUT terminals, CM, AE terminals open / shorted

### 2.8 Phase at EUT terminals, Common Mode

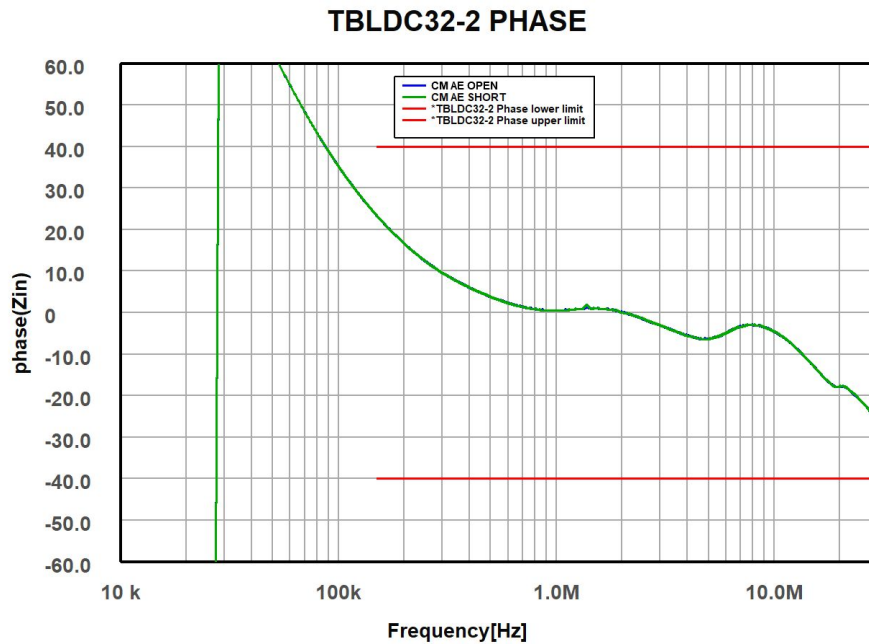

Figure 6 – Phase angle [ $^{\circ}$ ] vs. frequency at EUT terminals, CM, AE terminals open / shorted



## TBLDC32-2 V-Y-Δ DC-LISN

### 2.9 Impedance at EUT terminals, Differential Mode

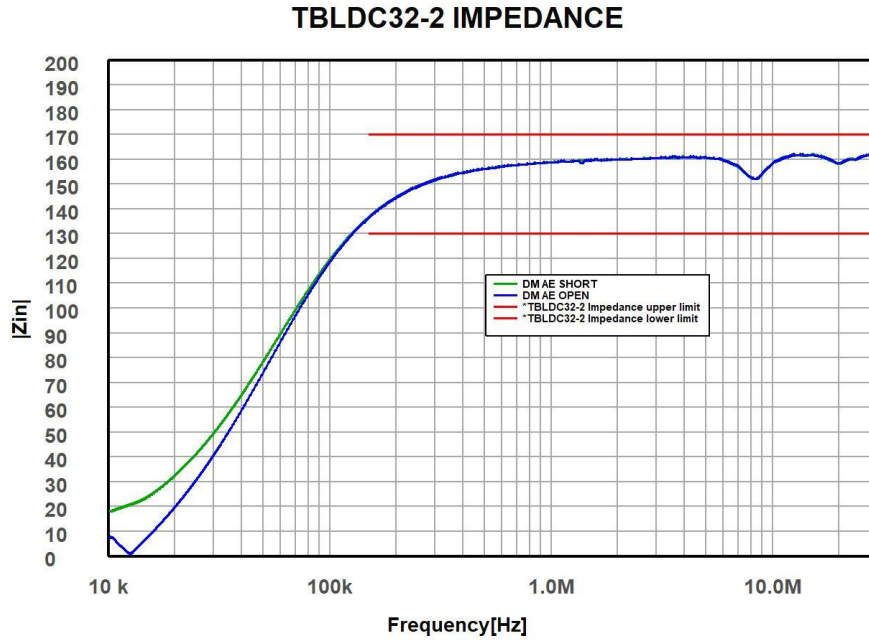

Figure 7 – Impedance [ $\Omega$ ] vs. frequency at EUT terminals, DM, AE terminals open / shorted

### 2.10 Phase at EUT terminals, Differential Mode

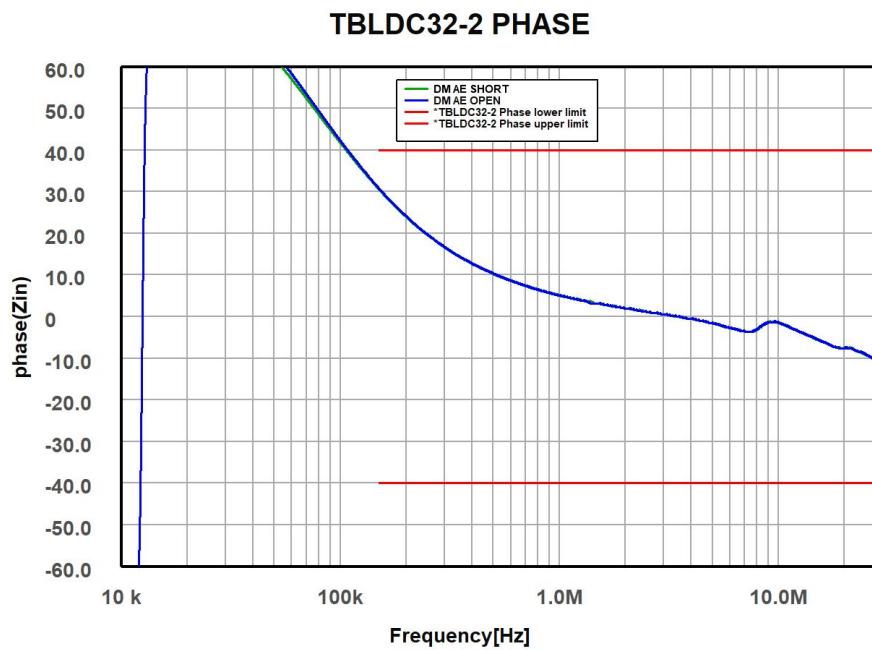

Figure 8 – Phase angle [ $^{\circ}$ ] vs. frequency at EUT terminals, DM, AE terminals open / shorted

## TBLDC32-2 V-Y-Δ DC-LISN

### 2.11 Voltage Division Factor

TBLDC32-2 Voltage Division Factor EUT - RF Output

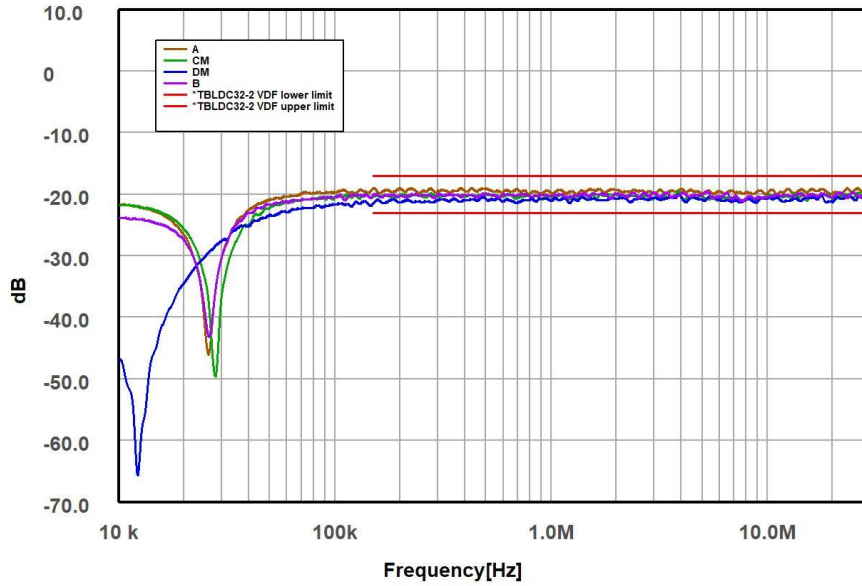

Figure 21 – Voltage Division Factor versus frequency

Frequency [MHz]	Typical Voltage Division Factor [dB]				Frequency [MHz]	Typical Voltage Division Factor [dB]			
	A	B	CM	DM		A	B	CM	DM
0.1	-19,59	-19,60	-20,44	-21,65	10	-19,18	-19,82	-20,71	-21,08
0.125	-19,44	-19,58	-20,40	-21,60	11	-19,25	-19,74	-20,36	-20,33
0.15	-19,39	-19,46	-20,44	-21,48	12	-19,04	-19,12	-20,35	-21,00
0.175	-19,72	-19,42	-20,31	-21,14	13	-19,50	-19,16	-20,18	-20,99
0.2	-19,76	-19,25	-20,61	-21,46	14	-19,12	-19,48	-20,39	-20,93
0.3	-19,37	-19,42	-20,53	-21,04	15	-19,77	-19,34	-20,38	-20,68
0.4	-19,14	-19,38	-20,09	-20,92	16	-19,65	-19,56	-20,58	-21,01
0.5	-19,67	-19,34	-20,26	-21,39	17	-19,69	-19,70	-20,97	-21,32
0.6	-19,76	-19,77	-20,12	-20,90	18	-18,67	-19,48	-20,58	-21,54
0.7	-19,49	-19,32	-20,33	-20,89	19	-20,00	-20,26	-20,30	-21,26
0.8	-19,49	-19,40	-20,33	-20,95	20	-20,35	-19,73	-20,73	-21,02
0.9	-19,84	-19,68	-20,81	-20,75	21	-19,58	-19,71	-20,29	-20,66
1	-19,52	-19,66	-20,47	-20,54	22	-19,52	-19,76	-20,58	-21,12
2	-19,59	-19,84	-20,06	-20,62	23	-19,14	-19,72	-20,61	-20,55
3	-19,35	-19,32	-19,92	-21,09	24	-19,50	-19,61	-20,42	-21,51
4	-19,51	-19,71	-20,50	-21,13	25	-19,47	-20,22	-19,69	-20,67
5	-19,31	-20,32	-20,96	-21,24	26	-19,40	-19,52	-20,59	-21,04
6	-19,51	-19,77	-21,18	-21,03	27	-19,35	-20,29	-20,07	-20,70
7	-19,04	-20,03	-20,80	-21,08	28	-19,35	-19,47	-20,71	-20,71
8	-19,57	-19,33	-20,91	-21,50	29	-19,51	-19,07	-20,35	-21,02
9	-19,85	-19,95	-20,62	-21,18	30	-19,31	-19,77	-20,82	-20,42

Table 1, Voltage Division Factor versus frequency

## TBLDC32-2 V-Y-Δ DC-LISN

### 2.12 Isolation

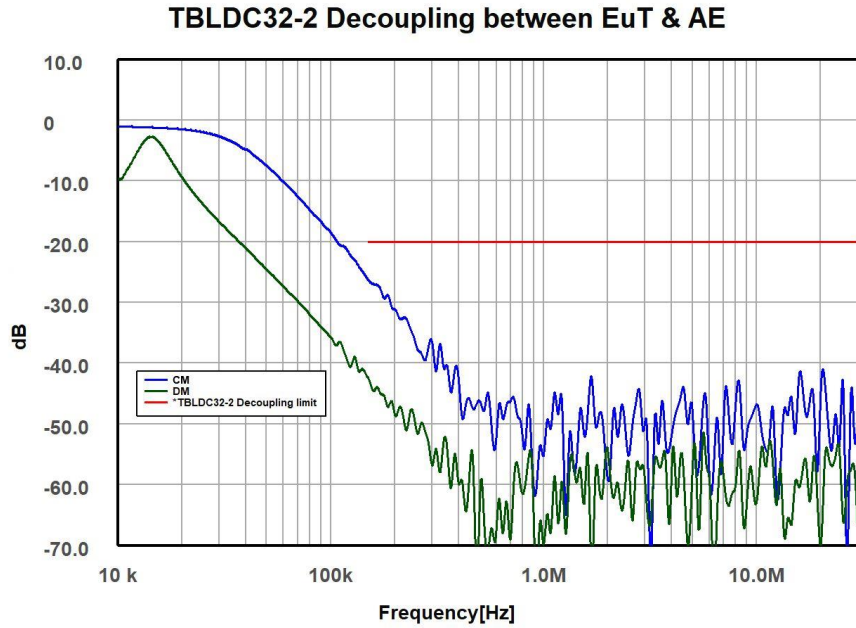

Figure 3: Decoupling between EUT and AE terminals for common mode and differential mode

### 2.13 Longitudinal Conversion Loss

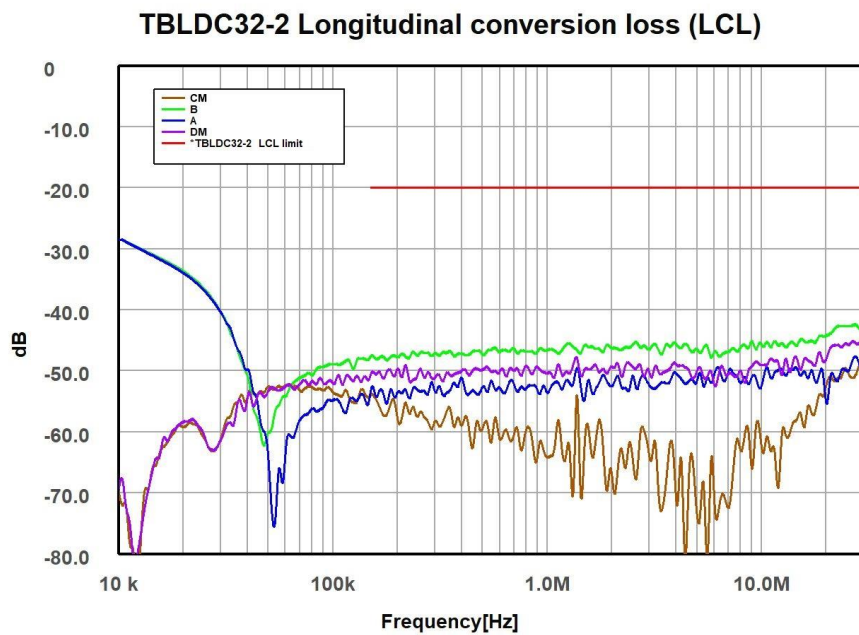

Figure 10 – Longitudinal Conversion Loss versus frequency

## TBLDC32-2 V-Y-Δ DC-LISN

### 2.14 Thermal characteristics

Avoid touching the housing, when operating the LISN at maximum current over extended time. Typical conducted noise measurements take less than 10 minutes per line. Turn off the DUT after measurements to avoid unnecessary dissipation.

At currents above 25A on each line simultaneously, limit measurement time to 20 minutes and allow the unit to cool down before carrying out further measurements.

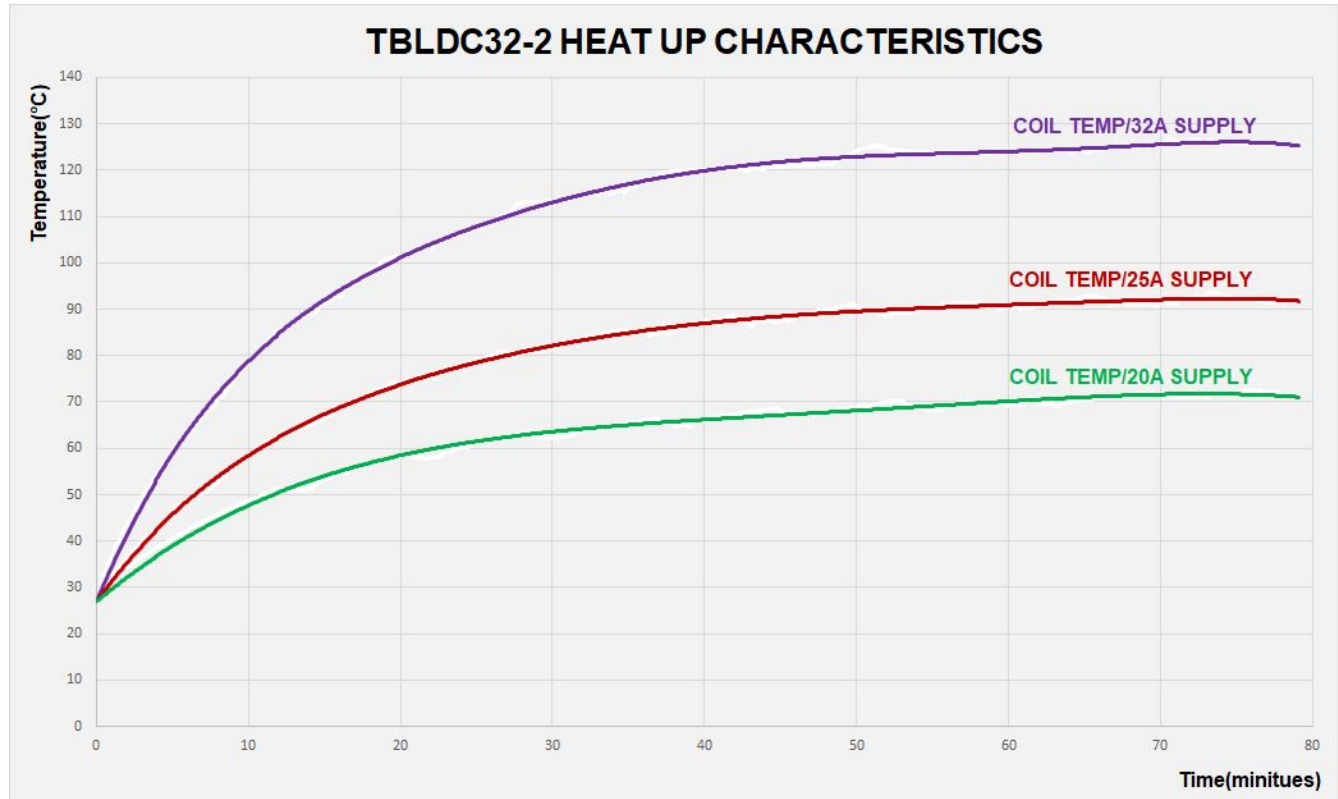

Figure 11: Coil temperature at 20 A, 25 A and 32 A EUT current, measured at @ 27 °C ambient temperature

### 2.15 Spectrum analyzer / EMI receiver RF input protection

The TBLDC2032-2 provides no protection against high voltage transients from the EUT appearing at the measurement receiver or analyzer input.

It is advised to use a combined attenuator/high pass filter/limiter or an external attenuator at the spectrum analyzer's RF input.

Tekbox provides a variety of suitable attenuators, filters, and limiters.

## TBLDC32-2 V-Y-Δ DC-LISN

### 3 Ordering Information

Part Number	Description
TBLDC32-2	V-Y-Δ DC-LISN

*Table 1– Ordering Information*

### 4 History

Version	Date	Author	Changes
V1.0	29.11.2022	Mayerhofer	Creation of the document

*Table 2– History*