

700MHz to 10GHz Dual- Polarized Dual-Vivaldi Array Antenna



Applications:

- 700 MHz to 10GHz
- 6061 Aluminum metal alloy
- Stainless Steel SMA-female
- Taiwan Design, Made in Taiwan

Features:

- DC Short lighting protection
- Low VSWR
- Uniform Gain
- Consolidated performance data base

Model: VC-07M10G-SF

LxWxH: 180x80x63mm

Connector: SMA-Female

Styling: Dual- Polarized Dual-Vivaldi Array

Gain: -14dbi- 4dBi

-3db Beam-width: Hor.74 deg- Ver. 52deg

N.W.: 130g

Frequency: 700MHz-10GHz

Polarization: Vertical or Horizontal

Max Power: 25 (peak)

Electrical Specifications

Frequency Range	700MHz – 10GHz
1GHz - 8GHz V.S.W. R	3.0:1 (avg)
Antenna Type	Dual- Polarized Dual-Vivaldi
Radiation	Directional
Gain	-14dBi - 4dBi
Antenna Factor	40 - 53 dB/m
Polarization	Vertical or Horizontal
Maximum Power	25 Watts
Vertical Beam-width	52 Deg
Horizontal Beam-width	74 Deg
Impedance	50 Ohm
FBR	7 db
Antenna Design	Array
Internal Material	R04533
Connector	SMA-Female

Mechanical Specifications

Length x Width (MAX)	180x80 mm
Diameter (MAX)	63 mm
Antenna Weight (G.W)	130 g
Application	Indoor
Parts Material	Fiberglass
L Mount Style	Optional
Mounting	Optional
Mount Style	Optional
indexing Ring Mounting	Optional
Storage Temperature	-20 to +100
Operating Temperature	-20 to +80
Operating Humidity	10%~70% non-condensing
Storage Humidity	5%~50% non-condensing
Safety, Emission and other	RoHS

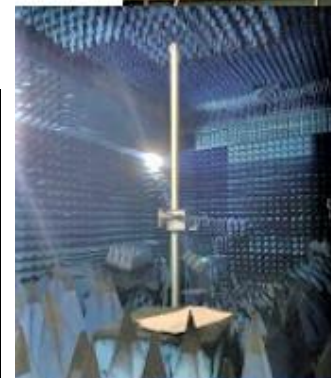

1MHz to 70GHz Antenna R&D. Manufacturing. OEM. ODM
Meet Various International Standards
High-Quality Made in Taiwan Antenna Products

Antenna Gain and Factor

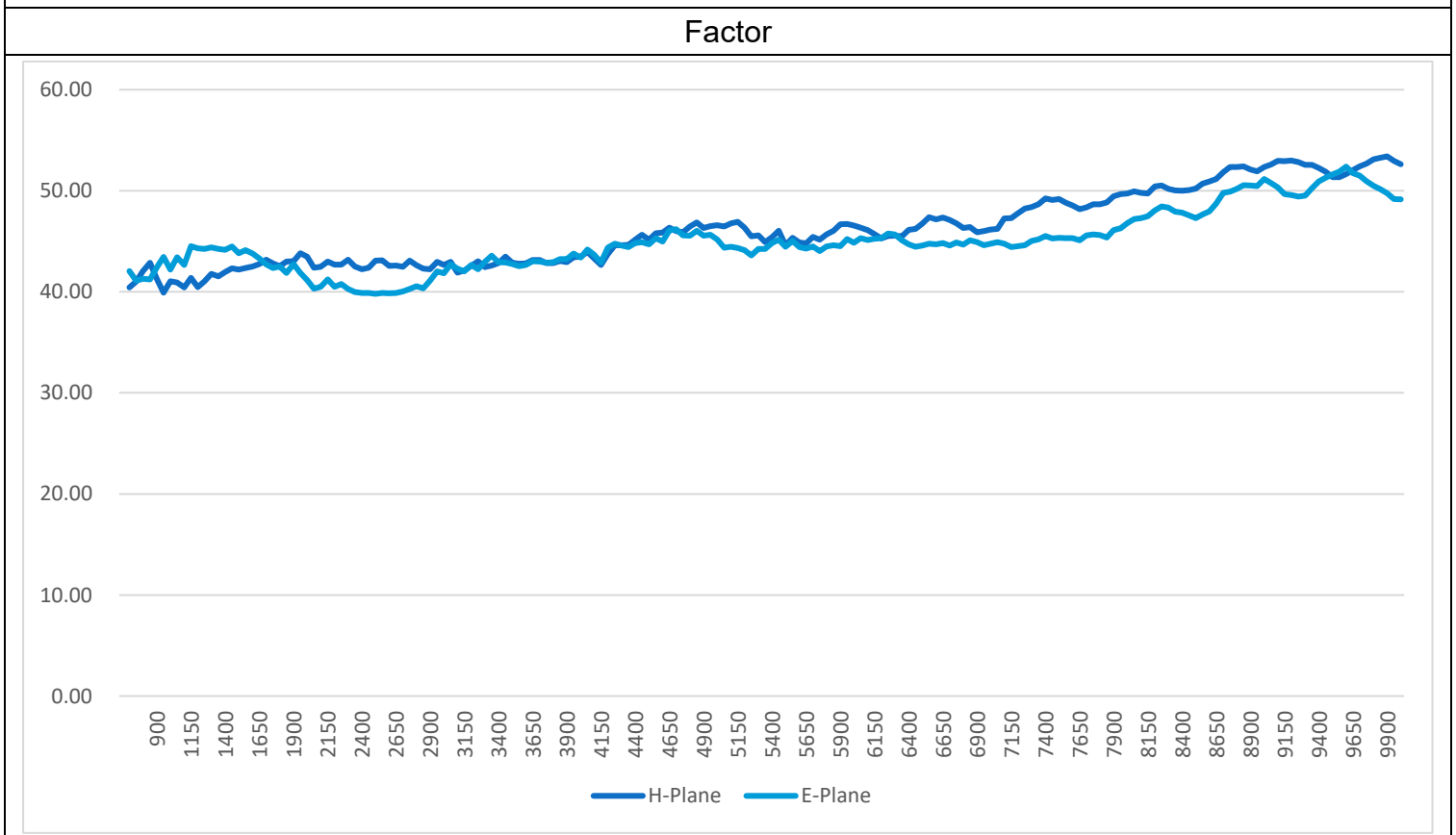
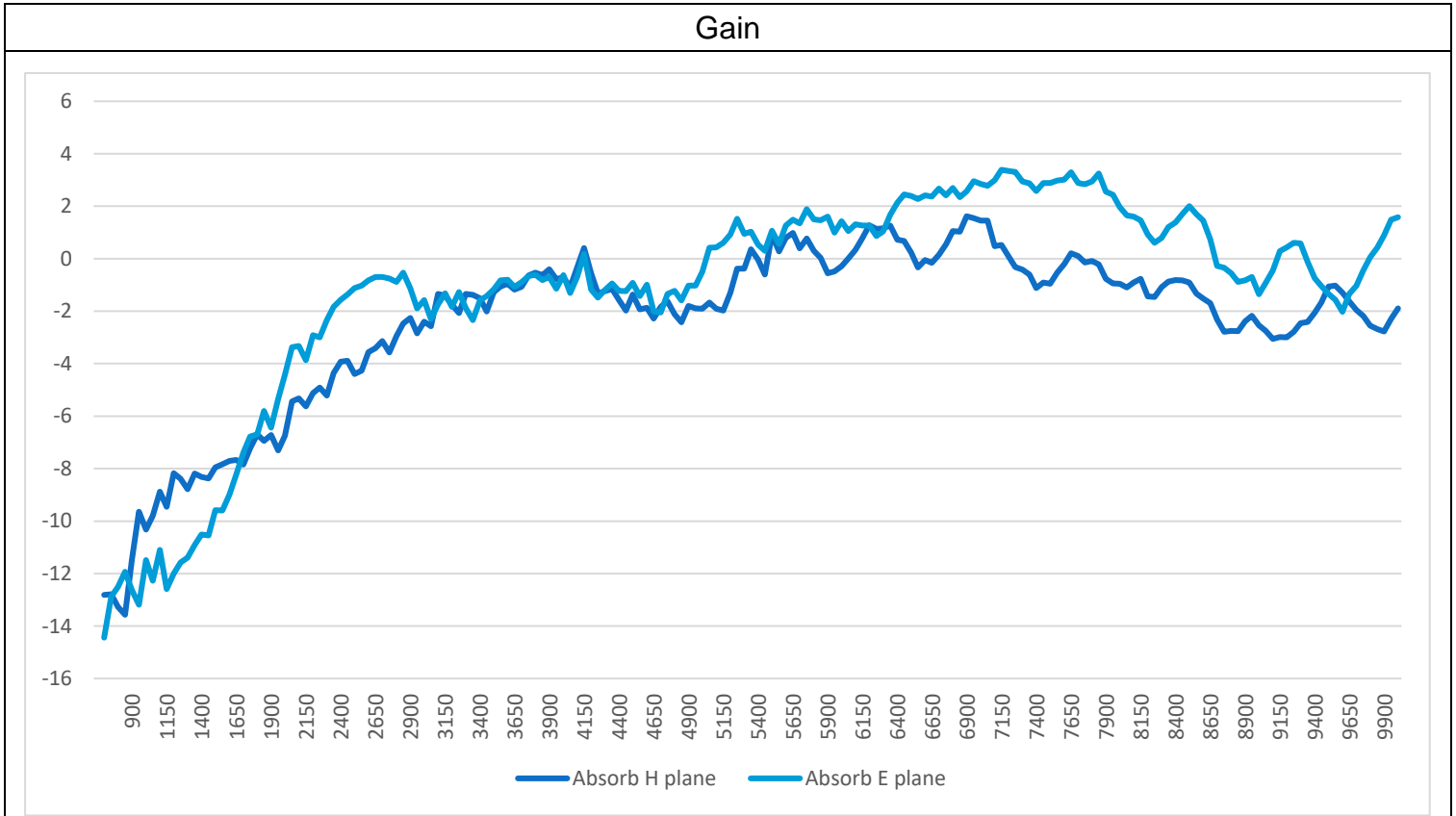

Antenna VSWR and Return loss

Test Equipment	Anritsu MS4644A 10Mhz-40Ghz
Test Equipment Cable	Agilent 60cm SMA Female to SMA Male
RF connector Adapter	N/A
Correction	85052D-DC-26.5Ghz
Test Model	VC-07M10G-SF
Test Port	S11

Return Loss & VSWR

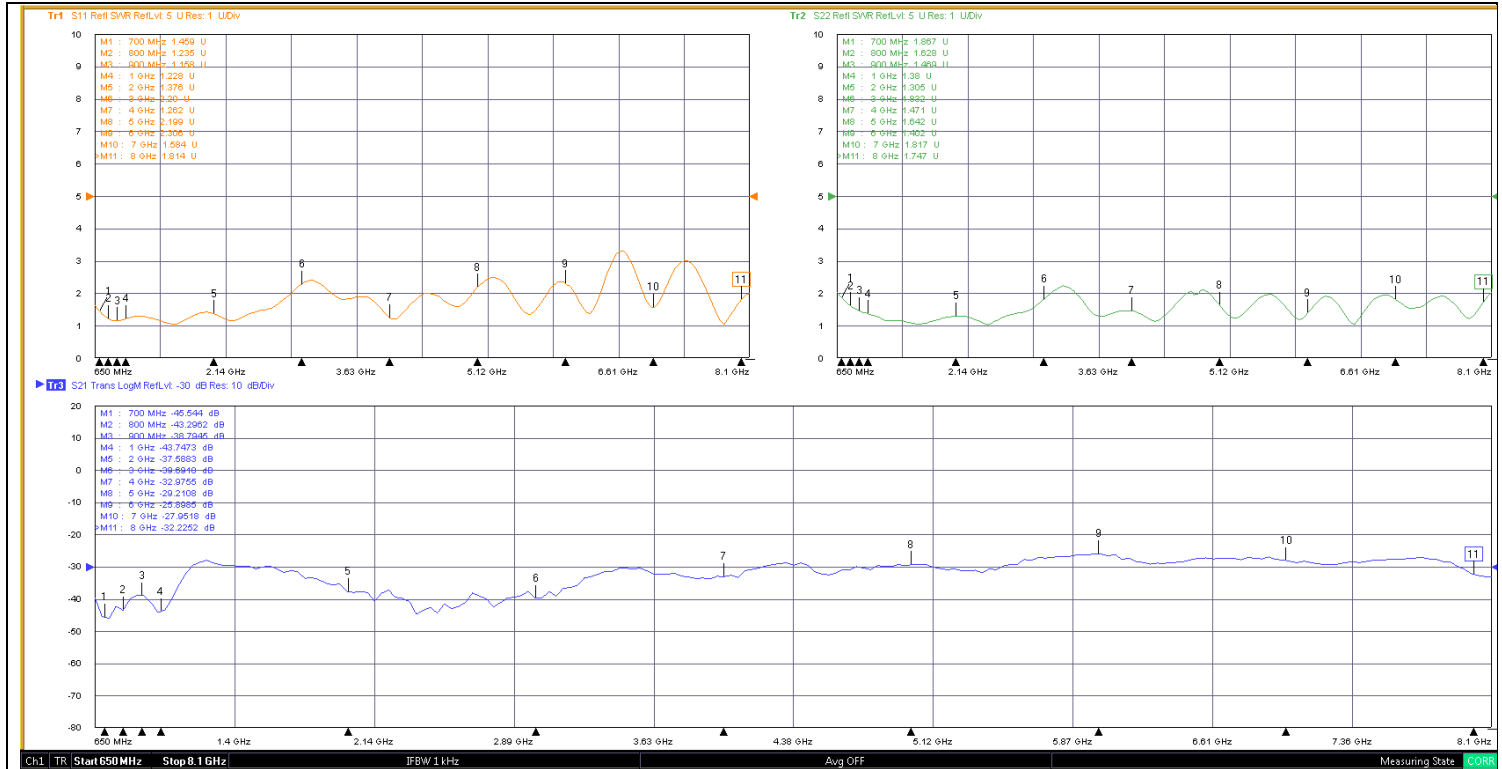

Antenna Pattern

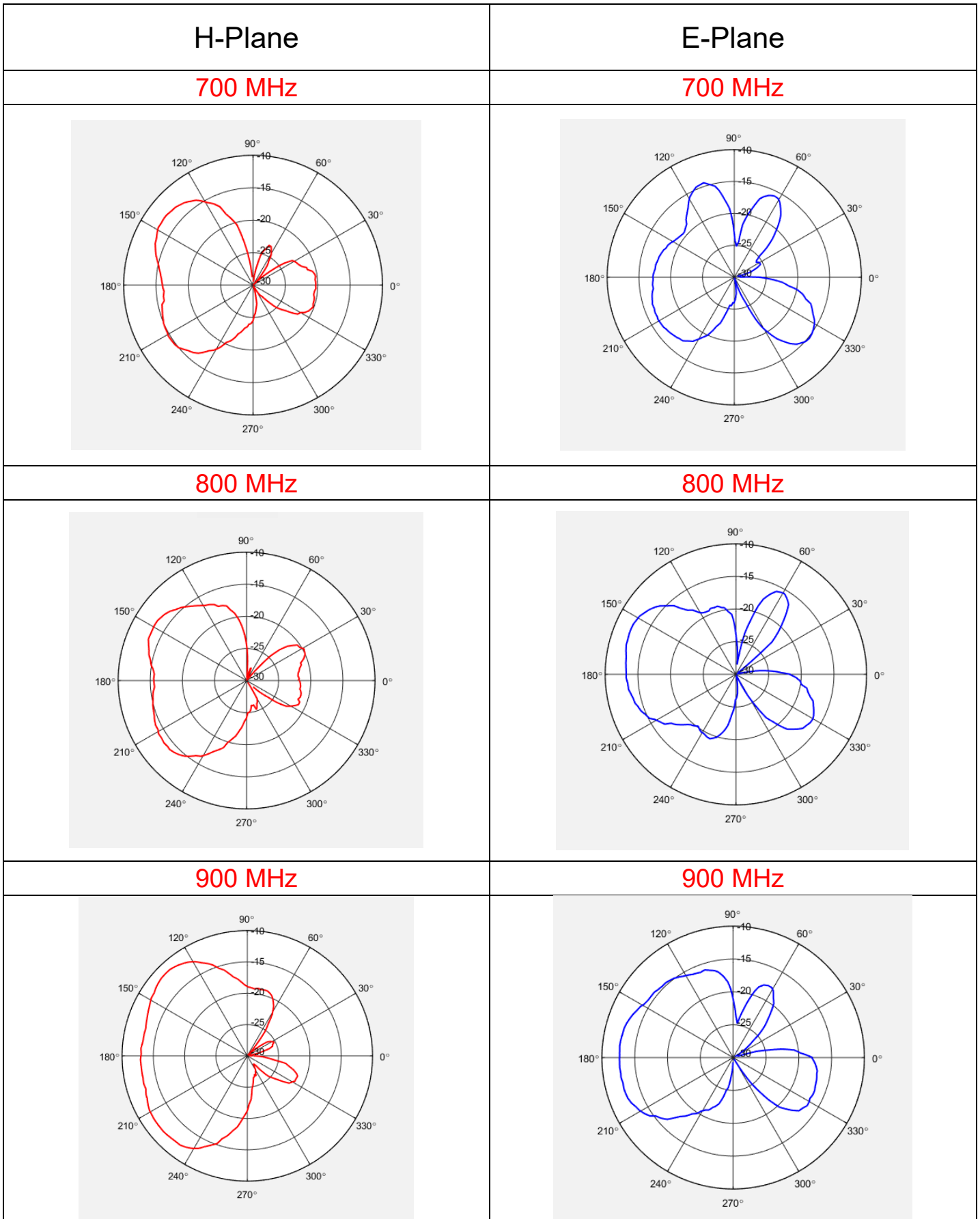

1000 MHz

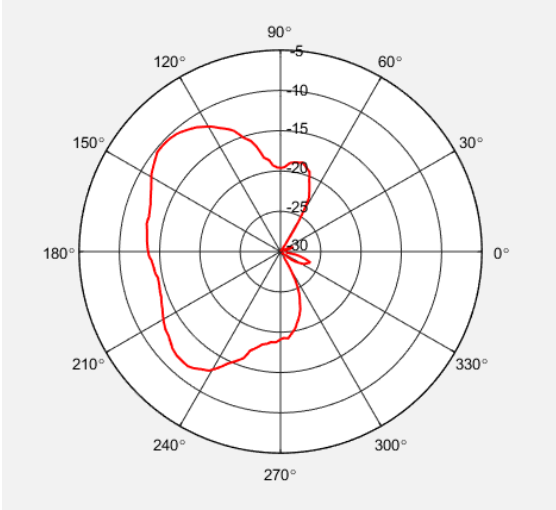

1000 MHz

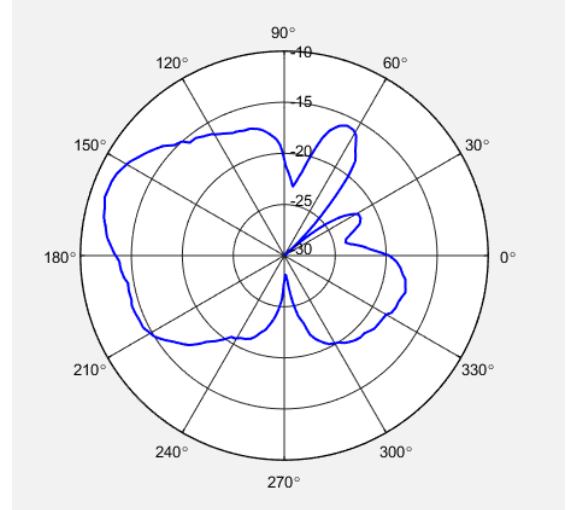

2000 MHz

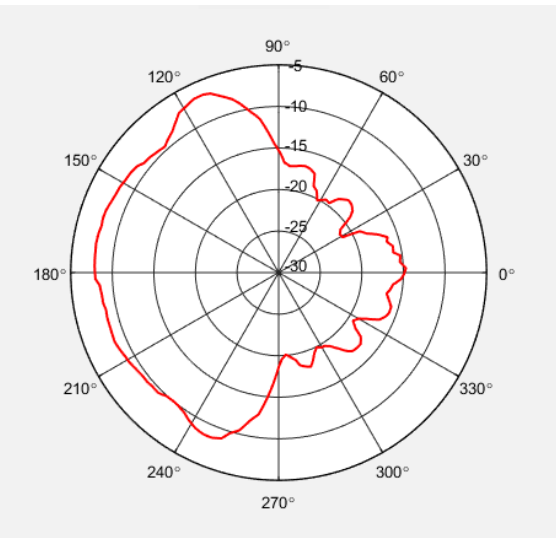

2000 MHz

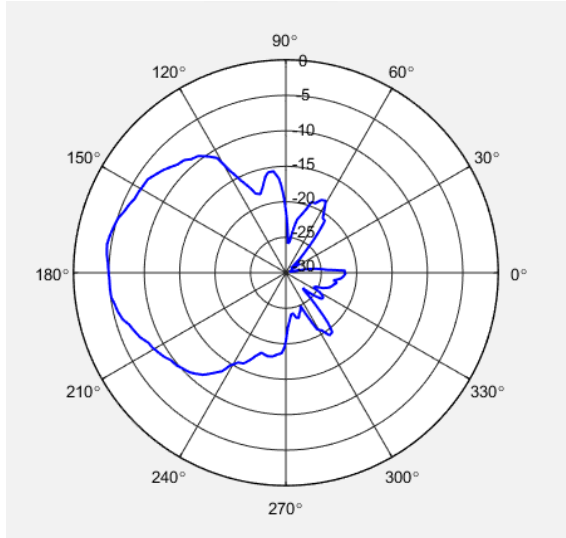

3000 MHz

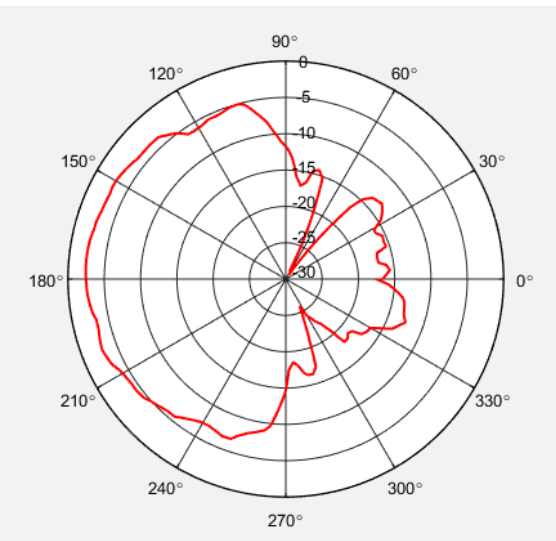

3000 MHz

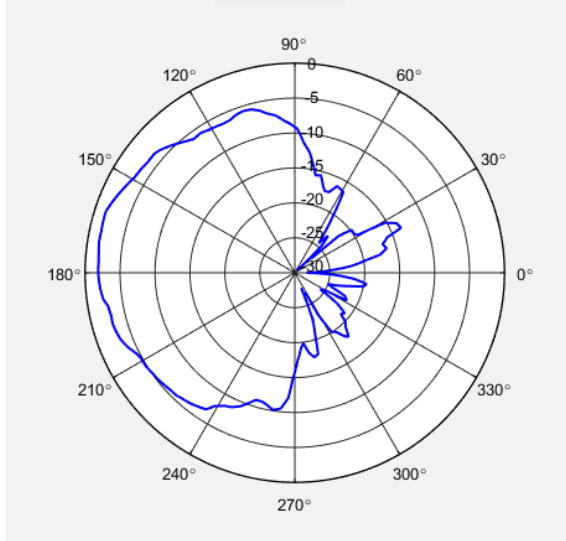

4000 MHz

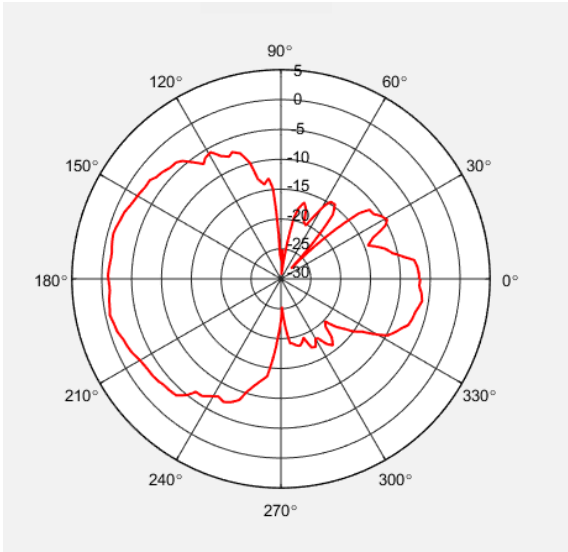

4000 MHz

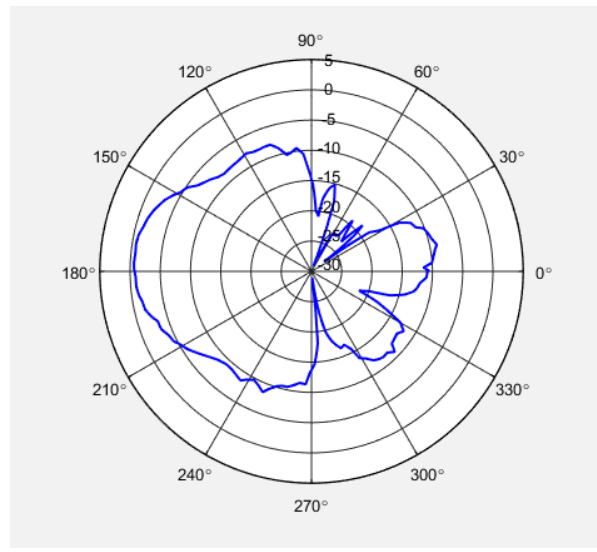

5000 MHz

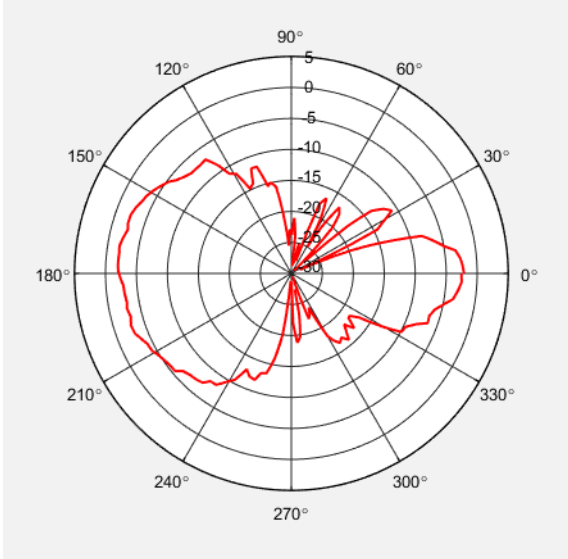

5000 MHz

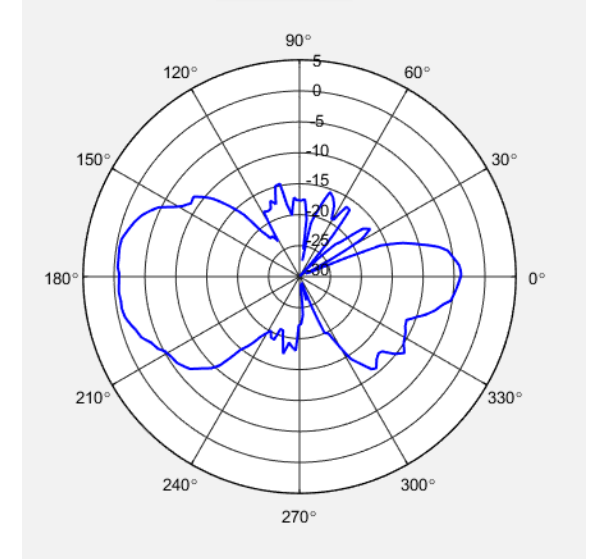

6000 MHz

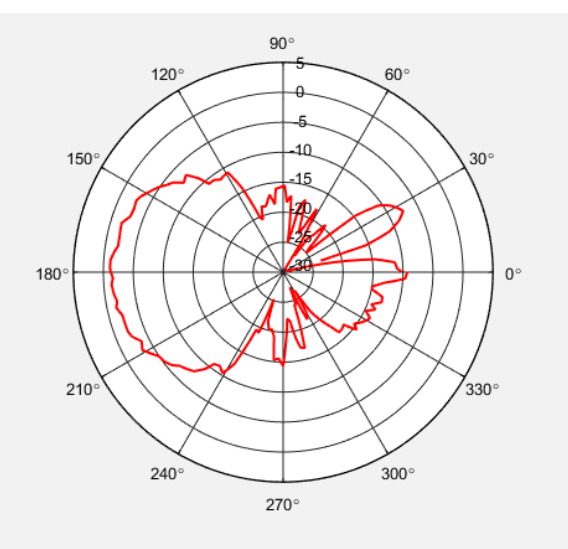

6000 MHz

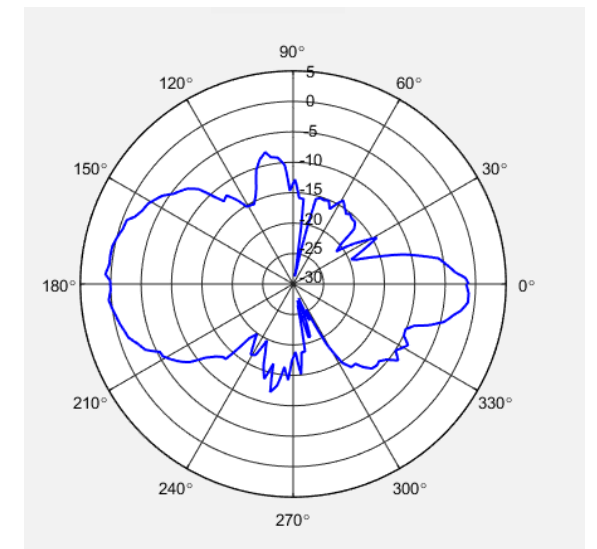

7000MHz

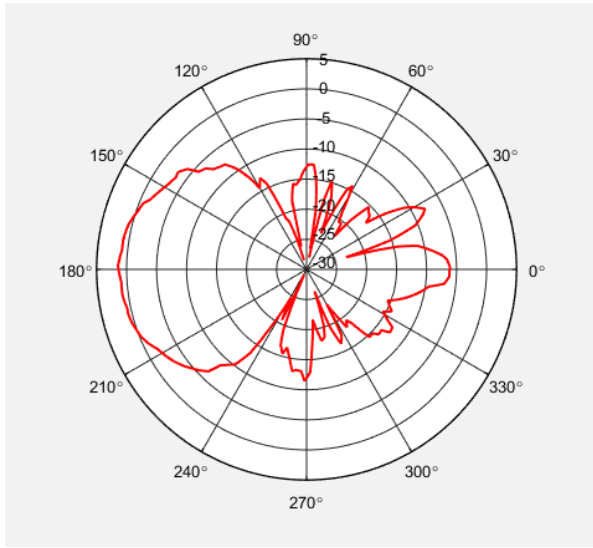

7000MHz

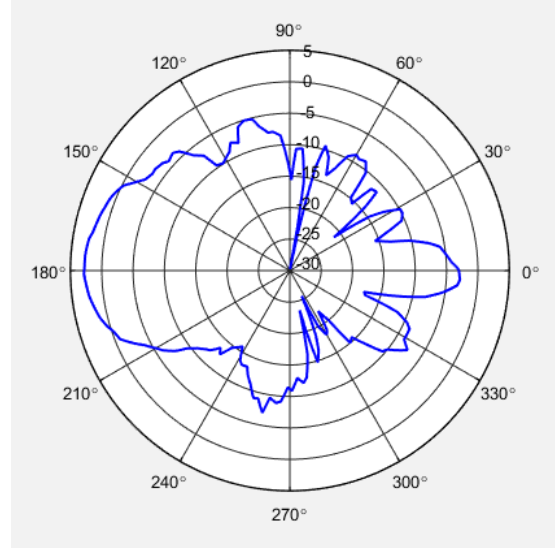

8000MHz

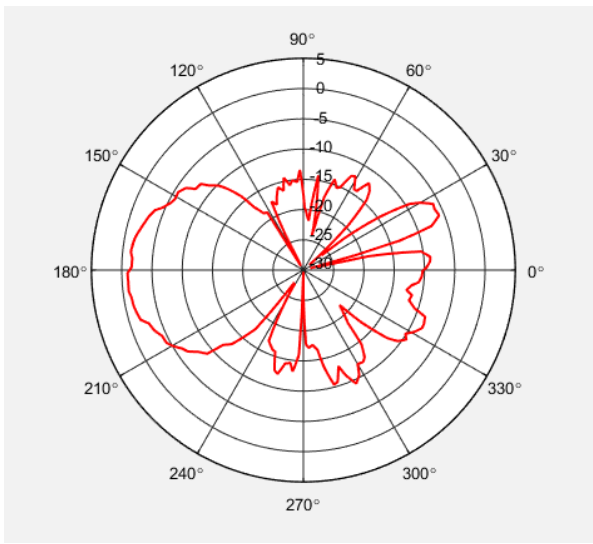

8000MHz

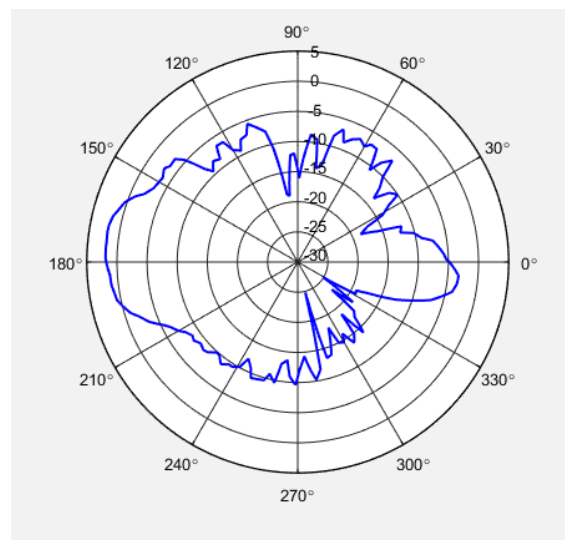

9000MHz

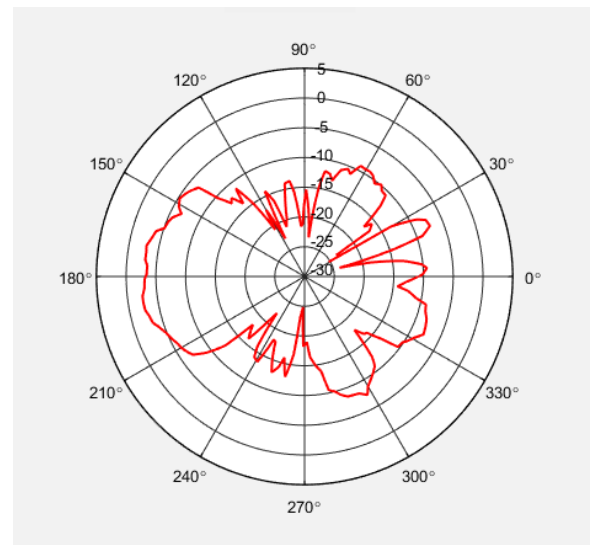

9000MHz

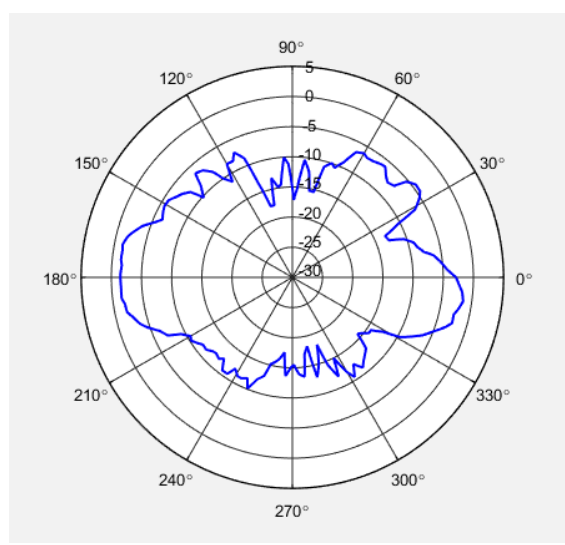

10000MHz

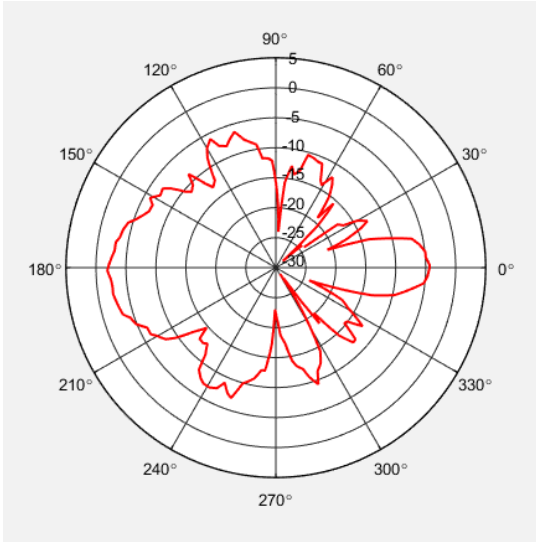

10000MHz

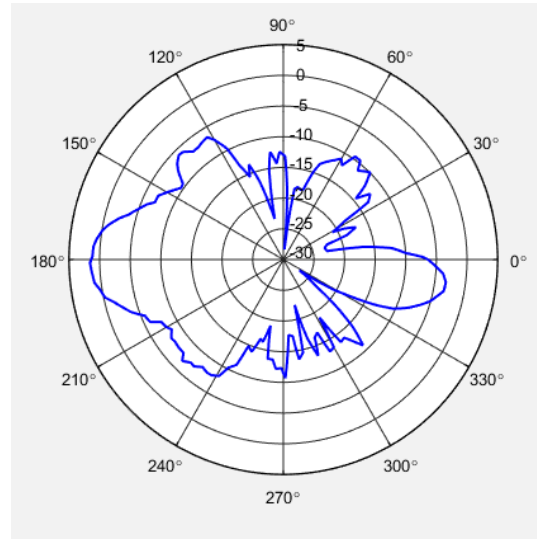

Antenna Gain

	H plane	E plane	H plane	E plane
Freq (MHz)	Gain (3M)	Gain (3M)	Factor (3M)	Factor (3M)
700	-12.81	-14.44	40.44	42.07
750	-12.79	-12.88	41.01	41.10
800	-13.27	-12.51	42.06	41.30
850	-13.57	-11.93	42.88	41.24
900	-11.48	-12.62	41.29	42.43
950	-9.64	-13.19	39.92	43.47
1000	-10.32	-11.48	41.04	42.20
1050	-9.79	-12.27	40.94	43.42
1100	-8.88	-11.1	40.43	42.65
1150	-9.45	-12.59	41.39	44.53
1200	-8.17	-12	40.48	44.31
1250	-8.39	-11.58	41.05	44.24
1300	-8.79	-11.39	41.79	44.39
1350	-8.19	-10.91	41.52	44.24
1400	-8.31	-10.51	41.96	44.16
1450	-8.37	-10.55	42.32	44.50
1500	-7.95	-9.58	42.20	43.83
1550	-7.83	-9.59	42.36	44.12
1600	-7.7	-8.98	42.51	43.79
1650	-7.67	-8.22	42.74	43.29
1700	-7.84	-7.39	43.17	42.72
1750	-7.22	-6.78	42.80	42.36
1800	-6.7	-6.69	42.53	42.52
1850	-6.94	-5.8	43.01	41.87
1900	-6.72	-6.44	43.02	42.74
1950	-7.3	-5.34	43.82	41.86
2000	-6.74	-4.42	43.48	41.16
2050	-5.44	-3.37	42.40	40.33
2100	-5.32	-3.32	42.49	40.49
2150	-5.63	-3.86	43.00	41.23
2200	-5.12	-2.92	42.69	40.49
2250	-4.91	-3	42.68	40.77
2300	-5.22	-2.34	43.18	40.30
2350	-4.36	-1.84	42.50	39.98

2400	-3.92	-1.56	42.25	39.89
2450	-3.89	-1.37	42.40	39.88
2500	-4.39	-1.12	43.07	39.80
2550	-4.26	-1.02	43.11	39.87
2600	-3.56	-0.82	42.58	39.84
2650	-3.41	-0.69	42.60	39.88
2700	-3.14	-0.7	42.49	40.05
2750	-3.57	-0.76	43.08	40.27
2800	-2.95	-0.88	42.62	40.55
2850	-2.47	-0.53	42.29	40.35
2900	-2.26	-1.13	42.23	41.10
2950	-2.84	-1.89	42.96	42.01
3000	-2.4	-1.58	42.67	41.85
3050	-2.57	-2.3	42.98	42.71
3100	-1.34	-1.74	41.89	42.29
3150	-1.41	-1.32	42.10	42.01
3200	-1.75	-1.83	42.58	42.66
3250	-2.07	-1.27	43.03	42.23
3300	-1.34	-1.88	42.43	42.97
3350	-1.38	-2.34	42.60	43.56
3400	-1.5	-1.59	42.85	42.94
3450	-2.01	-1.42	43.49	42.90
3500	-1.27	-1.16	42.87	42.76
3550	-1.06	-0.82	42.79	42.55
3600	-0.95	-0.8	42.80	42.65
3650	-1.18	-1.07	43.15	43.04
3700	-1.07	-0.9	43.16	42.99
3750	-0.64	-0.66	42.84	42.86
3800	-0.53	-0.61	42.85	42.93
3850	-0.62	-0.81	43.05	43.24
3900	-0.4	-0.69	42.94	43.23
3950	-0.78	-1.14	43.44	43.80
4000	-0.71	-0.62	43.47	43.38
4050	-1.08	-1.31	43.95	44.18
4100	-0.32	-0.68	43.30	43.66
4150	0.41	0.18	42.67	42.90
4200	-0.55	-1.18	43.74	44.37
4250	-1.32	-1.48	44.61	44.77

4300	-1.23	-1.19	44.62	44.58
4350	-1.15	-0.94	44.64	44.43
4400	-1.57	-1.22	45.16	44.81
4450	-1.97	-1.23	45.66	44.92
4500	-1.36	-0.92	45.15	44.71
4550	-1.93	-1.42	45.81	45.30
4600	-1.87	-0.99	45.85	44.97
4650	-2.28	-2.01	46.35	46.08
4700	-1.84	-2.04	46.01	46.21
4750	-1.62	-1.34	45.88	45.60
4800	-2.12	-1.22	46.47	45.57
4850	-2.42	-1.59	46.86	46.03
4900	-1.8	-1.03	46.33	45.56
4950	-1.89	-1.03	46.51	45.65
5000	-1.9	-0.5	46.60	45.20
5050	-1.67	0.42	46.46	44.37
5100	-1.9	0.43	46.77	44.44
5150	-1.97	0.61	46.93	44.35
5200	-1.29	0.92	46.33	44.12
5250	-0.38	1.52	45.51	43.61
5300	-0.38	0.95	45.59	44.26
5350	0.36	1.03	44.93	44.26
5400	-0.04	0.54	45.41	44.83
5450	-0.6	0.3	46.05	45.15
5500	0.92	1.06	44.61	44.47
5550	0.28	0.56	45.33	45.05
5600	0.8	1.27	44.89	44.42
5650	0.98	1.49	44.78	44.27
5700	0.4	1.35	45.44	44.49
5750	0.77	1.89	45.15	44.03
5800	0.3	1.5	45.69	44.49
5850	0.03	1.47	46.04	44.60
5900	-0.55	1.61	46.69	44.53
5950	-0.49	1	46.70	45.21
6000	-0.28	1.43	46.57	44.86
6050	0.01	1.05	46.35	45.31
6100	0.34	1.31	46.09	45.12
6150	0.79	1.26	45.71	45.24

6200	1.28	1.27	45.29	45.30
6250	1.13	0.87	45.51	45.77
6300	1.16	1.04	45.55	45.67
6350	1.27	1.67	45.51	45.11
6400	0.72	2.13	46.13	44.72
6450	0.68	2.45	46.23	44.46
6500	0.23	2.39	46.75	44.59
6550	-0.33	2.27	47.38	44.78
6600	-0.05	2.42	47.16	44.69
6650	-0.16	2.37	47.34	44.81
6700	0.15	2.67	47.09	44.57
6750	0.55	2.41	46.76	44.90
6800	1.05	2.7	46.32	44.67
6850	1.03	2.35	46.41	45.09
6900	1.62	2.57	45.88	44.93
6950	1.55	2.95	46.01	44.61
7000	1.45	2.85	46.18	44.78
7050	1.45	2.78	46.24	44.91
7100	0.48	2.99	47.27	44.76
7150	0.53	3.39	47.28	44.42
7200	0.09	3.34	47.78	44.53
7250	-0.32	3.31	48.25	44.62
7300	-0.41	2.94	48.40	45.05
7350	-0.6	2.87	48.65	45.18
7400	-1.12	2.58	49.23	45.53
7450	-0.91	2.88	49.08	45.29
7500	-0.95	2.89	49.17	45.33
7550	-0.53	2.98	48.81	45.30
7600	-0.2	3.02	48.54	45.32
7650	0.21	3.3	48.19	45.10
7700	0.1	2.88	48.35	45.57
7750	-0.14	2.84	48.65	45.67
7800	-0.09	2.94	48.66	45.63
7850	-0.22	3.25	48.84	45.37
7900	-0.77	2.56	49.45	46.12
7950	-0.94	2.44	49.67	46.29
8000	-0.95	1.97	49.74	46.82
8050	-1.1	1.65	49.94	47.19

8100	-0.91	1.61	49.80	47.28
8150	-0.77	1.46	49.72	47.49
8200	-1.43	0.93	50.43	48.07
8250	-1.46	0.61	50.51	48.44
8300	-1.08	0.79	50.18	48.31
8350	-0.87	1.21	50.03	47.95
8400	-0.81	1.38	50.02	47.83
8450	-0.82	1.7	50.08	47.56
8500	-0.91	2.01	50.22	47.30
8550	-1.33	1.7	50.69	47.66
8600	-1.52	1.45	50.93	47.96
8650	-1.69	0.74	51.15	48.72
8700	-2.31	-0.27	51.82	49.78
8750	-2.78	-0.34	52.34	49.90
8800	-2.75	-0.56	52.36	50.17
8850	-2.76	-0.88	52.42	50.54
8900	-2.39	-0.82	52.10	50.53
8950	-2.18	-0.7	51.94	50.46
9000	-2.54	-1.35	52.35	51.16
9050	-2.75	-0.92	52.61	50.78
9100	-3.05	-0.45	52.95	50.35
9150	-2.99	0.29	52.94	49.66
9200	-3	0.43	53.00	49.57
9250	-2.78	0.61	52.83	49.44
9300	-2.46	0.58	52.55	49.51
9350	-2.41	-0.12	52.55	50.26
9400	-2.06	-0.74	52.25	50.93
9450	-1.66	-1.05	51.89	51.28
9500	-1.06	-1.34	51.34	51.62
9550	-1.03	-1.57	51.35	51.89
9600	-1.29	-2.02	51.66	52.39
9650	-1.62	-1.34	52.03	51.75
9700	-1.95	-1.04	52.41	51.50
9750	-2.19	-0.44	52.69	50.94
9800	-2.55	0.06	53.10	50.49
9850	-2.68	0.42	53.27	50.17
9900	-2.77	0.89	53.41	49.75
9950	-2.29	1.49	52.97	49.19

10000	-1.89	1.58	52.61	49.14
-------	-------	------	-------	-------

Antenna -3db Beamwidth Curve

Frequency (MHz)	H-Plane (Deg)	E-Plane (Deg)
700	59	28.5
800	117.4	74.7
900	136.4	100.1
1000	59.6	71.2
2000	125.1	63.1
3000	100.6	72.8
4000	91.8	49.9
5000	67.2	46.8
6000	62.9	46.2
7000	51.5	45.3
8000	46.6	39.2
9000	49.4	38.5
10000	40.3	26.1
AVG	74.09	52.47

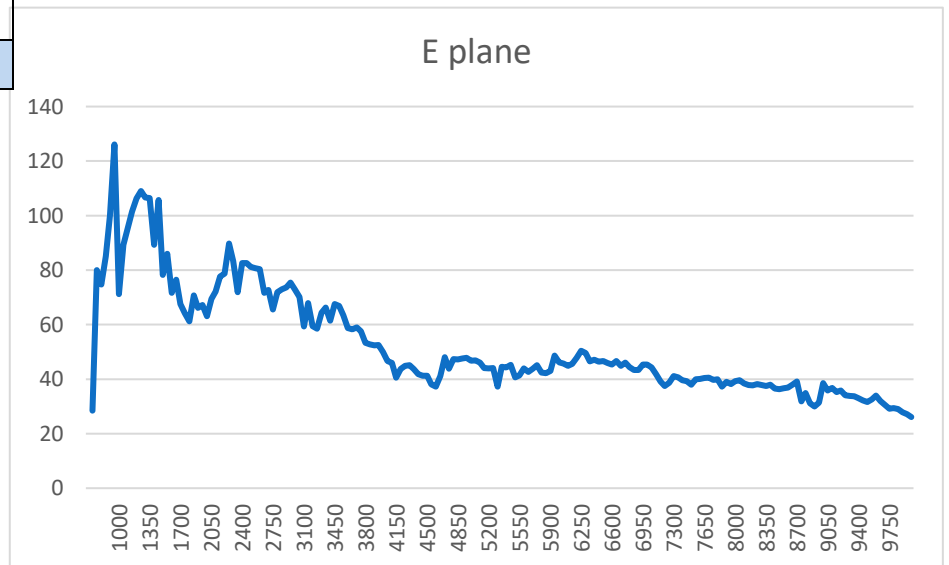
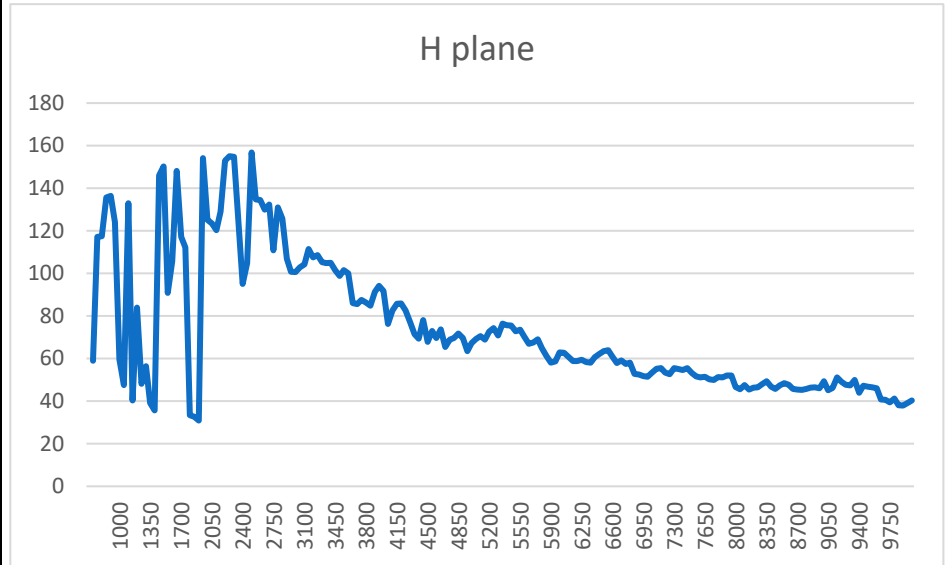

Antenna FBR Curve

Frequency (MHz)	H-Plane (dB)	E-Plane (dB)
700	7.5	4.71
800	7.8	3.87
900	10.23	3.99
1000	16.31	6.1
2000	10.75	17.11
3000	10.08	18.02
4000	5.94	8.2
5000	0.23	3.36
6000	8.18	1.82
7000	7.5	5.68
8000	7.98	5.17
9000	4.74	0.08
10000	2.42	4.78
AVG	6.25	7.26

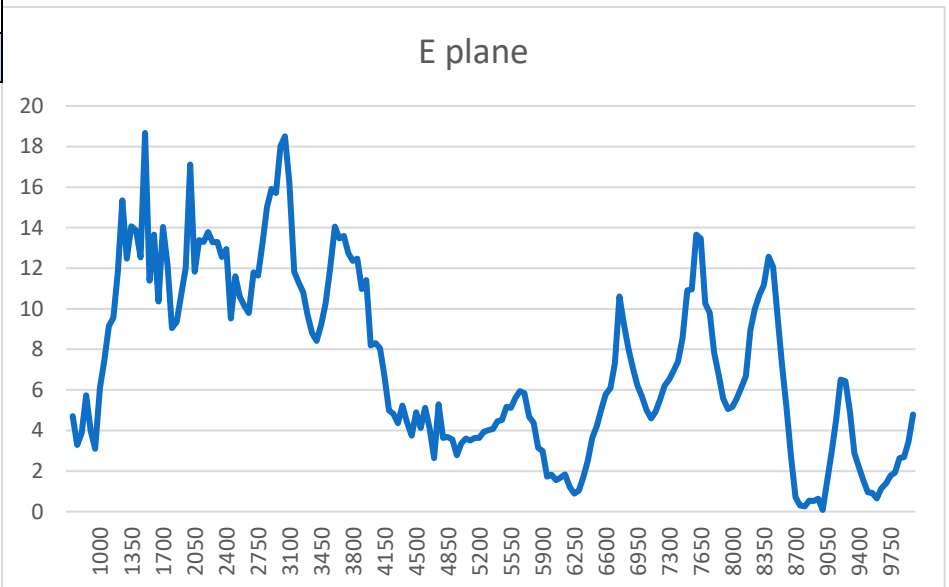
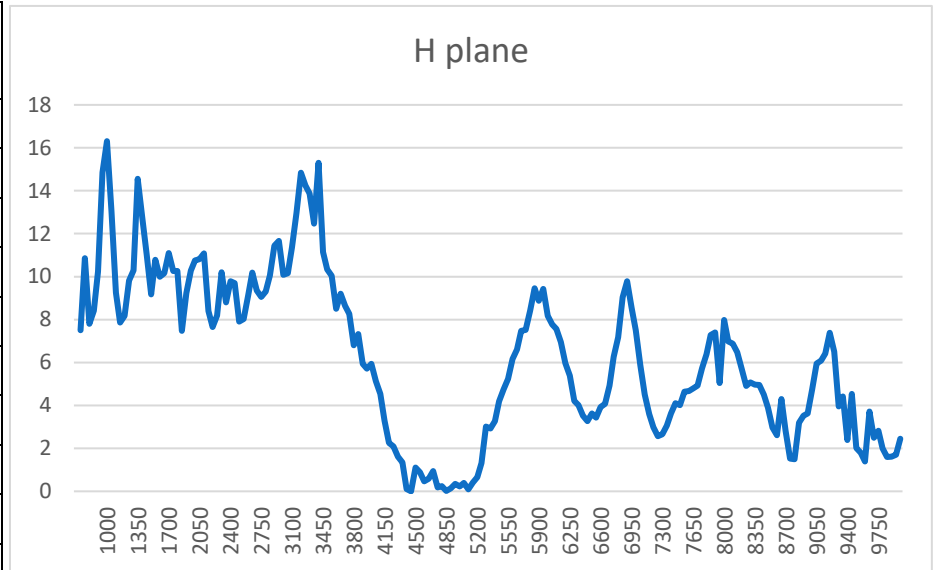

Antenna Dimension

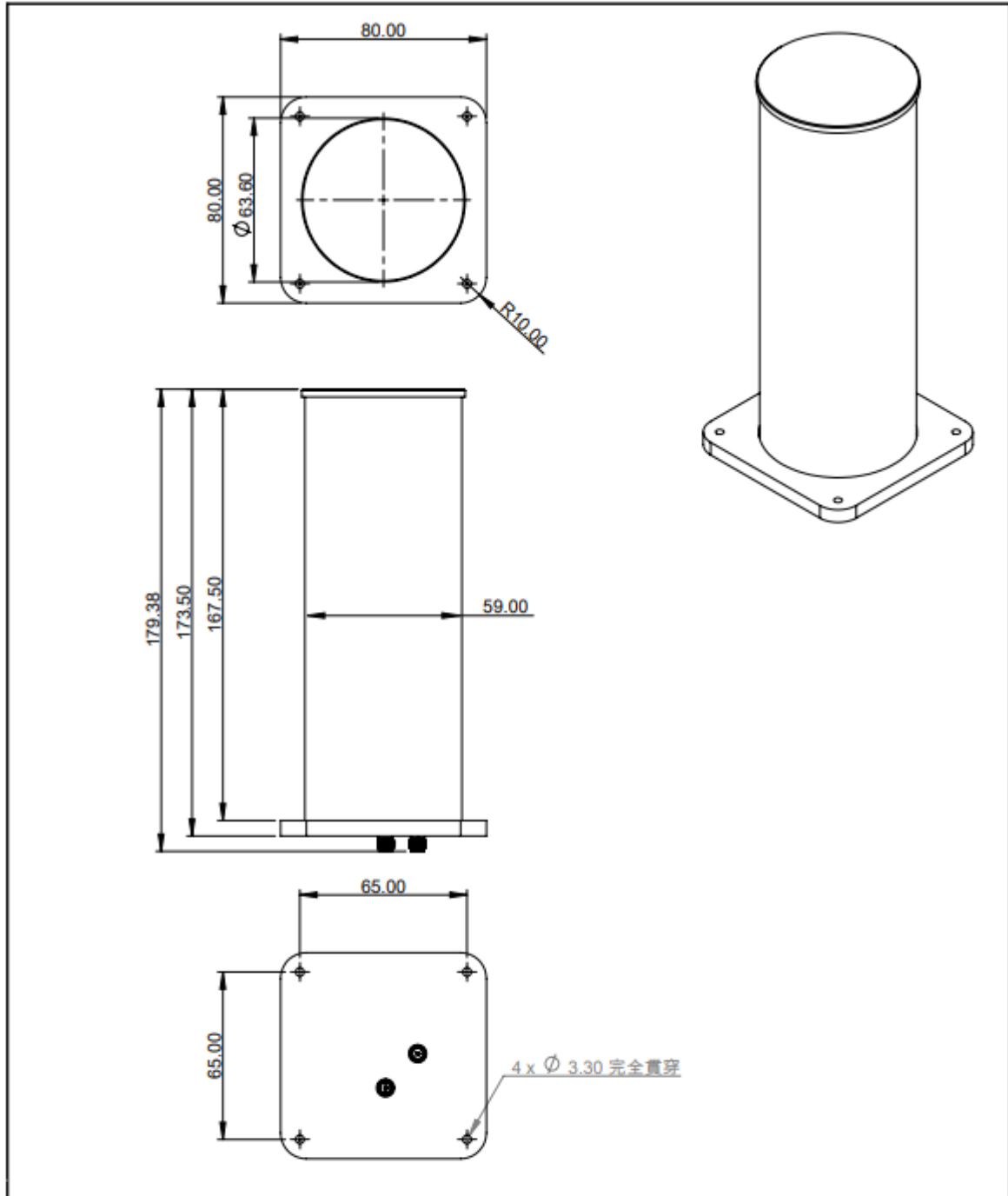

DRAWER		NAME	8-8	DATE	MATERIAL			飛騰無線科技有限公司 Fei Teng Wireless Technology CO.,LTD	
CONFIRM		TSAI		2021/5/24	WEIGHT (g)	129.46	EDGE		
APPROVED		Jockie		2021/5/24	MATERIAL SUPPLIER		EDITION	V1	TITLE VC-07M10G-SF
PROCESS		Xinying		2021/5/24	PRODUCTION METHODS				
QA				2021/5/24	SUPPLIER				
PACKAGE DELIVERY NOTE					FINISH				
EDITION	DATE	MODIFY CONTENT	EDITION	DATE	MODIFY CONTENT	PART NO.			
V1						DEPARTMENT		SHIPPING NOTE	POSITION
V2						TEL		03-5882899	DATE
						FAX		03-5882879	2021/5/26
File No. C:\SOP-PM\PM-2021\VC-07M10G-SF\								Make in Taiwan For FT-RF Design SHEET 2 OF 2 SCALE: 1:2 A4	

Packing List & Label List

	1 Set Packing			
	Antenna			
	ITEM NO.		VC-07M10G-SF	
	Q'TY		1 PCS	
	G. W.		130 G	
	N. W.		130 KG	
	CARTON			
1 set carton Label			Antenna Label	
Size	50 x 80 mm(white)		Size	30 x 50 mm(blue)
Customer:	Manufacture Data: yy/mm/dd		VC-07M10G-SF 700MHz to 10GHz Dual- Polarized Dual-Vivaldi Array Antenna	
Customer Mode:				
Order Number:				
Weight:	kg			
Carton:	Box			
Amount:	Pcs			
Paste Position			Paste Position	

RoHs and WEEE Status (RoHs and WEEE Compliant)

Certificate of Compliance

Date:

To: Whom It May Concern

FT-RF hereby certifies that product:

Model	Product
VC-07M10G-SF	700MHz to 10GHz Dual- Polarized Dual-Vivaldi Array Antenna

Is in conformance with the requirements of the European RoHS Directive 2011/65/EU and the European WEEE Directive 2012/19/EU, all materials referenced therein are in concentrations below the maximum allowable levels specified. Products manufactured by FT-RF bear the CE marking and have FCC certificate. FT-RF has been assessed and found to be in accordance with the requirements of ISO 14001:2015 and ISO 9001:2015 standards, scope of Design and Manufacture of Antenna.

Our statements in this letter regarding RoHS and WEEE compliance do not extend to, or apply to any product subjected to unintended contamination, misuse, neglect, accident, improper installation, or to use in violation of instructions furnished by FT-RF.

Sincerely,

FT-RF (Fei Teng Wireless Technology CO., LTD)

The information contained in this letter is being provided for informational purposes only and to clarify certain information concerning FT-RF products. Nothing provided in this letter is:

- (1) a representation, warranty, or agreement to indemnification by FT-RF.
- (2) a statement which may form the basis of reliance by FT-RF,
- (3) a modification of any of the terms and conditions of sale agreed to in writing between FT-RF and its customers with respect to any FT-RF products, whether previously sold or to be sold in the future.